



Face ID 4

Face Recognition System for
Time Attendance

User Guide

CONTENTS

- 3-4 CHAPTER 1 • GETTING STARTED**
Viewing the User Guide on the Internet
Included Accessories
Included Printed Materials
Installation Tips
Activating Terminal
Registering Warranty
- 5-8 CHAPTER 2 • BASICS**
Introduction
Overview
The Display of LCD Panel
Main Menu
Touch Keypad
Keyboard
Date/Time
Voice Control
Security Features
Cleaning
Restarting and Resetting
- 9-12 CHAPTER 3 • CONNECTION – SYNCING TERMINALS**
Installation
Mount on Wall
Communication Diagrams
Description of Available Connections
TCMS V2 Online Activation
Installation and Setup of TCMS V2
Connecting The Terminals to TCMS V2
Using USB to Download/Upload Data
Communication Key
- 13-15 CHAPTER 4 • USER**
Enrolling Users
Voice / Message
Face Verification
Adding User Information
Deleting User
Access Level/Privilege
- 16-18 CHAPTER 5 • SYSTEM**
General Settings
Display Settings
Face Settings
Log Settings
System Information
- 19-20 CHAPTER 6 • DATA**
Deleting Transaction Logs
Deleting All Data
- 21 CHAPTER 7 • USB**
Understanding the Need for USB Flash Disk
Type of USB
Downloading Attendance Logs
Downloading User Data
Uploading User Data from USB to Terminal
Uploading User Photo
- 22 CHAPTER 8 • SHORTCUT KEY**
Shortcut Keys in Short
Configuring Shortcut Keys
- 23 CHAPTER 9 • AUTO TEST**
Who should do the Auto Test?
Is the Screen OK?
Checking the Voice Message
Checking the Infrared Camera
Is the Time Accurate?
- 24 CHAPTER 10 • CALIBRATION**
Calibrating Screen Sensitivity to Default Level
- 25 CHAPTER 11 • BELL**
Definition of Schedule Bell
Inserting Day and Time to Trigger Schedule Bell
Determining the Ring Type of Schedule Bell
Repetition
State
- 26 TROUBLESHOOTING**

1 • GETTING STARTED

Viewing the User Guide on the Internet

The User Guide is available in the package when you purchase the product. The User Guide is also published online at fingertec.com and user.fingertec.com. Choose the language you prefer to view the User Guide in.

Included Accessories

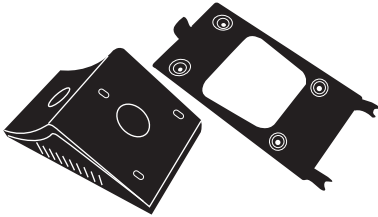

Metal Back Plate

Secure this plate on top of the rubber cushion and place the terminal onto it.

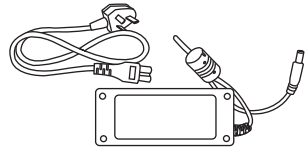

DC 12V Power Adaptor

Connect the power adaptor to the terminal and plug it into a standard power outlet to charge the terminal.

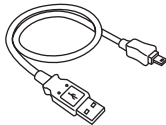

USB Extension

To connect to the USB port of a computer for uploading and downloading of data.

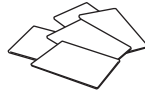

RFID Cards (5 pcs)

FingerTec provides extra cards for RFID (5pcs) and Mifare Card, (1pc).

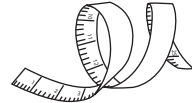

Measurement Tape

To measure the installation height to achieve optimum performance for terminal.



A Packet of Bolts

Use the bolts to mount the back plate of the terminal on the wall.

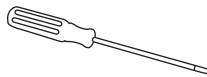

T10 Screwdriver

T10 screwdriver to open the back plate of the terminal for installation.

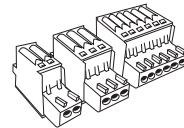

Connectors

To connect the wires to a door lock or a doorbell if required.



Stylus

For easy navigation on the touch screen LCD panel.

Included Printed Materials

- FingerTec Comprehensive DVD
- Quick Start Guide
- User Enrollment Template Form
- Warranty Card

Installation Tips

Best installation location for Face ID 4:

1. Avoid facing strong sunlight.
2. Must be at least 2 meters away from any strong light source e.g. fluorescent ceiling light
3. The height must be at least 1.2m from the ground level to the Face ID 4 camera.

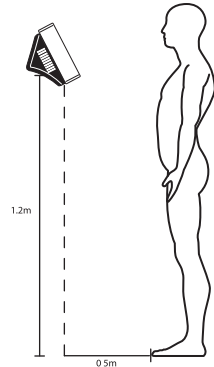

Activating Terminal

Every FingerTec access control model comes bundled with a unique license key. To start using the terminal with TCMS V2, you must connect the terminal to TCMS V2 and perform online activation. TCMS V2 reads the serial number of your terminal and sends it for verification at the FingerTec server via Internet.

In case you do not have an Internet connection, you would need to do offline activation. Please send the serial number and models of your terminals to your local resellers or support@fingertec.com to request for a product key and activation key.

Registering Warranty

Make sure that you register your Face ID 4 warranty with us at fingertec.com/ver2/english/e_main.html#.

2 • BASICS

Introduction

Introducing Face ID 4, the new facial recognition technology product combined with card technology. Face ID 4 can identify an identity in split seconds without any contact or hassle. It only requires a user to look at the machine to get verified.

Face ID 4 is loaded with powerful microprocessor that can process facial authentication method for accurate personal identification and for collection of precise data for time attendance and door access. In addition, the Face ID 4 terminal accepts card verification as an added security measure. If you are looking for a contactless, hassle free biometrics product, choose Face ID 4. With one look you are good to go!

Overview

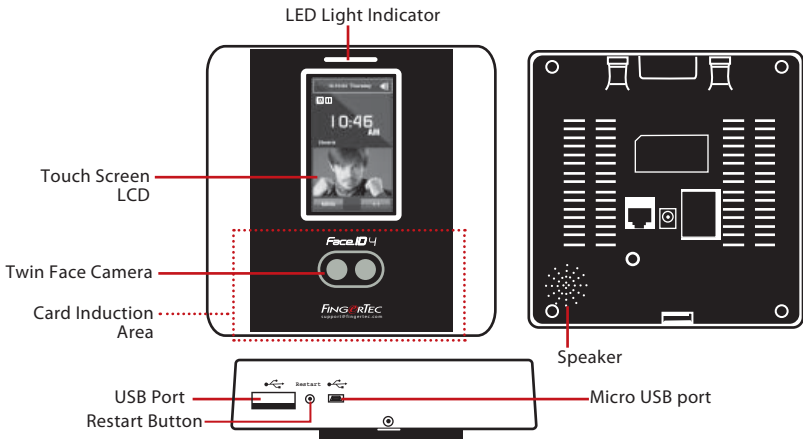

Item	Function
Card Induction Area	Read the card information based on the card system of Face ID 4.
Touch Screen LCD	Touch to access into Face ID 4 system to do configuration.
LED Light Indicator	Indicate the status of reader. Green indicates standby mode or verification is successful. Red indicates problem or verification has failed.
Speaker	Emit instructions from Face ID 4.
Twin Face Camera	Capture face images in a few directions.
Reset Button	To restart the machine.
USB Port	Connect the USB flash disk to download/upload data from/to Face ID 4.
Micro USB Port	Connect Face ID 4 directly to pc/laptop to download/upload data with TCMS V2.

The Display of LCD Panel

Take a closer look at the touch screen LCD panel for some basic and important information. Press moderately on the LCD when input commands to maintain a longer lifespan of the terminal. Clean the camera area with a microfiber cloth to maintain the performance of face scanning.

STANDBY MODE

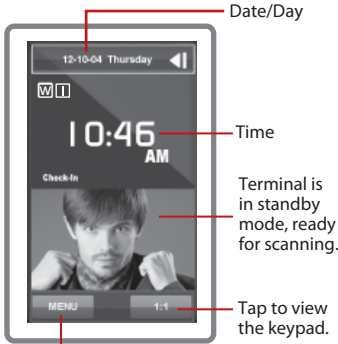

ENROLLMENT MODE



VERIFICATION MODE

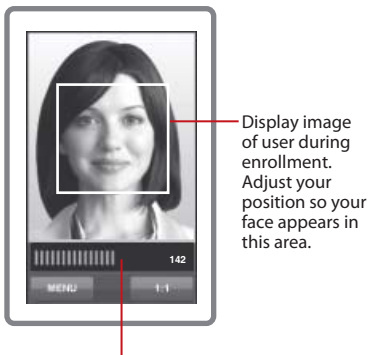

SUCCESSFUL VERIFICATION MODE

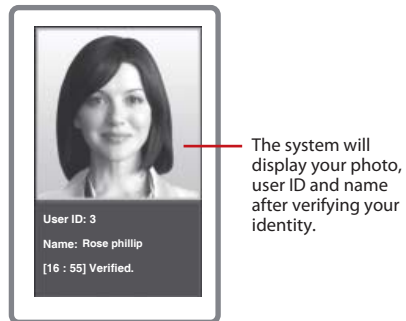

Main Menu



New User: Add new user to the Face ID 4.

User: Enroll, edit, delete and insert user information from User icon. The Face ID 4 allows storage of 400 facial images.

Connection: Setup the Face ID 4 communication with computer through LAN. Set communication with a computer for a secure data transfer.

System: Configure the settings of the Face ID 4 including attendance and update settings.

Data: Check user attendance and transaction logs that are available in the Face ID 4 and perform housekeeping of the terminal.

Date/Time: Shortcut to set date/time into the Face ID 4.

Auto Test: Run tests on the Face ID 4 to diagnose the terminal on various aspects.

USB: Transfer data to and from the Face ID 4 using a USB flash disk.

Sys Info: Show basic information of the Face ID 4 and its storage status.



Touch Keypad

Press 1:1 to view the touch keypad. You can input information into the Face ID 4 through the touch keypad. It contains numbers from 0-9, Cancel, and Backspace buttons.

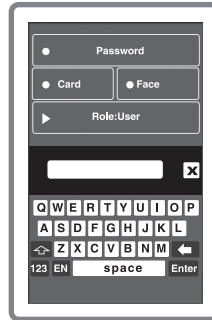

Keyboard

Use the onscreen QWERTY keyboard to type in alphabet and number input into the Face ID4.

Type Upper Case: Tap the arrow pointing up on the left corner of the keyboard to change the lowercase to upper case.

Type Number: Tap the 123 key to change the keyboard to display numbers.

Return: Tap Enter to return. Tap X on the keyboard top right corner when you are done using the onscreen keyboard.

Date/Time

The Face ID 4 displays date and time at the home screen. Choose a date and time format based on your preference. Press Menu > Date/Time > Select value > Save. You can select the time format to be either the 12-hour format or the 24-hour format.

Voice Control

Voice Control lets you control the level of volume emitted by the Face ID 4.

Turn On/Off – The Face ID 4 lets you to turn on/off the voice based on your preference. Press Menu > System > General > Voice Prompts > On/Off > Save.

Adjust Volume: The default volume of the Face ID 4 voice is Mid (medium). To sustain the performance of speaker in Face ID, the volume is recommended to remain at Mid value. To adjust the volume Press Menu > System > General > Volume > Select Low | Mid | High

Security Features

Security features help protect the information in the Face ID 4 from being accessed by others.

Admin Affirm: Register an administrator into the system by enrolling a face or password to a user ID. Press Menu > New User > Privilege: Administrator > Choose enrollment method > Save.

After enrolling an administrator, the main menu can only be accessed by administrator.

Tamper Switch: The Face ID 4 comes with a tamper switch located at the rear of the terminal. During installation, the tamper switch is compressed against the back plate. Any attempt to dismantle the Face ID 4 will trigger the internal alarm and the LCD panel will display "System Broken" to notify users.

Cleaning

Please turn off the terminal before cleaning it.

Clean Touch Panel: Use a microfiber cloth to clean the Face ID 4. Do not use any liquids, household cleaners, aerosol spray, solvents, alcohol, ammonia and abrasive solutions to clean the touch screen panel of the Face ID 4 because it could damage the panel.

Restarting and Resetting

If something isn't working right, try restarting or resetting the Face ID 4.

Restarting the Terminal: At the bottom of Face ID4, look for the Restart button use a pin, press the button once to restart the terminal.

Resetting the Terminal: Go to Menu > Data and click on Restore to Factory Settings. Press Yes to confirm. Resetting of Face ID 4 will cause all your settings to return to the original factory settings.

3 • CONNECTION – SYNCING TERMINALS

Installation

FingerTec terminals offer several connections for power and communications. To install the Face ID 4, follow the instructions below.

Mount On Wall

Attach the back plate on to the wall securely and attach the terminal on to the back plate when mounting it on the wall.

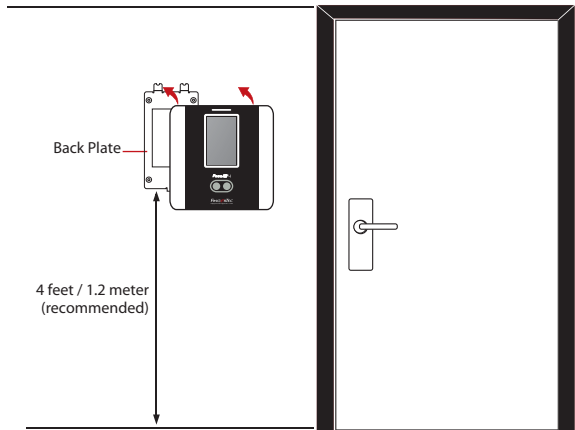

Communication Diagrams

Connection points for power and communication are available at the back of the terminal. Refer to the following diagrams for the correct installations.

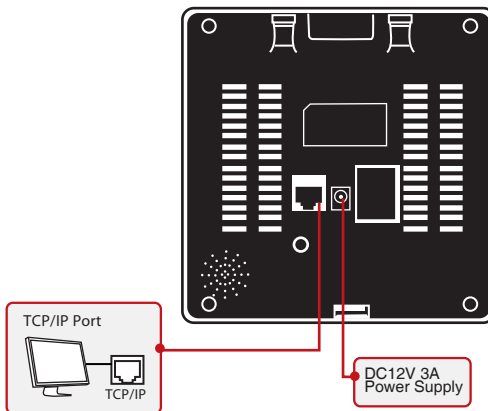

Descriptions of Available Connections

USB PORT

Linking with USB flash disk for remote data transfer.



TCP/IP PORT

Connect with a CAT 5 cable for LAN connection, one end to terminal's port and another end to the computer's TCP/IP Port.

TCP/IP for Single Connection

Linking the terminal to a single computer using TCP/IP requires Ethernet 10/100Base-T Crossover Cable. The cable can be used to cascade hubs or to connect Ethernet stations back-to-back without a hub. It works with both 10Base-T and 100Base-TX.

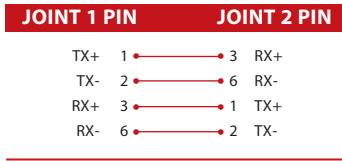

TCP/IP for Network Connection

Linking the terminals to multiple computers using TCP/IP requires Ethernet 10/100Base-T Straight Thru Cable or "whips". The cable works with both 10Base-T and 100Base-TX, connecting a network interface card to a hub or network outlet.

	CONNECTOR PIN	CABLE COLOR	CONNECTOR	
TX+	1	White/Orange	1	TX+
TX-	2	Orange	2	TX-
RX+	3	White/Green	3	RX+
	4	Blue	4	
	5	White/Blue	5	
RX-	6	Green	6	RX-
	7	White/Brown	7	
	8	Brown	8	

POWER SUPPLY PORT

Insert the Power Adapter point to this port for power.

ACCESS CONNECTION *(Only applies to Face ID 4d)*

Links the terminal to a door lock system.

NOTE Link all cables to the correct connection point(s) before attempting to connect the terminals to the software.

TCMS V2 Online Activation

TCMS V2 is a genuine software by FingerTec. Every FingerTec access control model comes bundled with a unique license key. To start using the terminal with TCMS V2, you must connect the terminal to TCMS V2 and perform online activation. TCMS V2 reads the serial number of your terminal and sends it for verification at the FingerTec server via Internet.

In case you do not have an Internet connection, you would need to do offline activation. Please send the serial number and models of your terminals to your local resellers or support@fingertec.com to request for a product key and activation key.

Installation and Setup of TCMS V2

Install TCMS V2 in a PC that fulfills the software's minimum requirements. Refer to user.fingertec.com/user-promanual.htm for the TCMS V2 user guide online. Setup Wizard will require you to do online activation before a connection can be established between TCMS V2 and the terminals.

Connecting Terminals to the TCMS V2

DETERMINING THE TERMINAL NUMBER

Identify the number of your terminals to differentiate them between one another. TCMS V2 can connect up to 999 units of terminal. Press Menu > Options > Comm Opt > Dev Num > Select the number.

USING TCP/IP

IP address is important, as it is a unique address of the terminal in LAN. Without the IP address, locating the specific terminal is not possible. **To input the IP address of the terminal:** Press Menu > Options > Comm Opt > IP Addr > Key in IP address.

SETTING UP ETHERNET

It is important to setup the Ethernet to connect the terminals using TCP/IP connection. **Setting up the Ethernet is done by enabling the Ethernet function:** Press Menu > Options > Comm Opt > Ethernet > Yes.

Turn off the terminal after you have set the Ethernet setting to Yes. Now, plug-in the network plug to the Ethernet interface and turn the power on.

Determining the Netmask, Gateway and NetSpeed: For TCP/IP connection, please configure the netmask, gateway and netspeed for the terminal.

Press Menu > Options > Comm Opt > NetMask > Insert the numbers.

Press Menu > Options > Comm Opt > Gateway > Insert the numbers.

Press Menu > Options > Comm Opt > NetSpeed > Choose the speed of your Ethernet connection.

USING RS232 CONNECTION

For connection via RS232, baudrate is the determinant of communication speed between the terminal and the software. The higher the baudrate, the faster the speed is.

To turn on RS232 connection and set the baudrate: Press Menu > Options > Comm Opt > RS232 > Change the RS232 connection to Y.

To change baudrate: Press Menu > Options > Comm Opt > Baudrate > Change the Baudrate accordingly.

USING RS485 CONNECTION

For connection via RS485, baudrate is also the determinant of communication speed between the terminal and the software but the speed must be according to the speed of the converter. Check your converter for the speed.

To turn on RS485 connection and set the baudrate: Press Menu > Options > Comm Opt > RS232 > Change the RS485 connection to Y.

To change baudrate: Press Menu > Options > Comm Opt > Baudrate > Change the Baudrate accordingly.

Using USB to Download/Upload Data

A USB flash disk is useful in cases where the terminal is installed far from a PC or there is a connection problem. To determine the type of USB flash disks compatible with the terminal, please refer to this link at fingertec.com/newsletter/HL_74.html using USB

Press Menu > PenDrive Mgmt > Choose the operation that you want to carry out via USB flash disk.

Communication Key

Since the software is controlled by an activation code and a product key, set the COMM key to zero. Press Menu > Options > Comm Opt > COMM Key > Set to 0.

4 • USER

Enrolling Users

The Face ID 4 can contain up to 400 face templates and 10,000 card users.

FACE ENROLLMENT

One face registration would take approximately 30 sec to complete. The terminal snaps images of your face and generates a 3 dimensional template for storage. During enrollment on the Face ID 4, please stand straight and do not move your face or body, and make sure that your face is calm with no extreme expression. For height between 150cm to 180cm, recommended distance between the Face ID 4 and user is 0.5m.

To enroll face: Press Menu > New User > User ID > Insert User ID > Select Face > A green rectangular box will be displayed on the screen > Align your eye position into the green box > Adjust your head position to align your eyes into the green box > repeat 2 times > Face enrollment is complete > Select Privilege > User > Save

CARD ENROLLMENT

The default card for the Face ID 4 is RFID. MiFare card system available upon requests.

To enroll card: Press Menu > New User > User ID > Insert User ID > Select Card > Wave the card at the scanning area until the screen displays the Card ID > Select Privilege > User > Save

PASSWORD ENROLLMENT

The Face ID 4 offers different enrollment methods and password can be used alone or in combination with the face recognition methods. The maximum length of a password is 8 digits.

To enroll password: Press Menu > New User > User ID > Insert User ID > Select Password > Input password using the touch keypad > OK > Reconfirm password > OK > Select Privilege > User > Save

Voice / Message

Voice / Message	What Does It Mean?
"Verified"	Identity verification is successful, the Face ID 4 stores the transaction logs and opens the door (if connected to door access)
"Try again please"	Identity verification failed because the face is not properly positioned, the template is not available in the Face ID 4 or the password is incorrect.

Voice / Message	What Does It Mean?
"Admin Affirm"	You are not the administrator of the system and you cannot access Menu page.
"Invalid ID"	For 1:1 verification, User ID entered does not match the face.

Face Verification

1:N – 1:N verification does not require any input of your user ID. Stand in front of the Face ID 4 until you can see the reflection of your face on the panel and look at the cameras. The Face ID 4 takes a second to verify your face.

1:1 – 1:1 requires input of User ID before the Face ID 4 reads and verifies. Press 1:1 > Input ID on the screen > Press face icon > the Face ID 4 reads and verifies. Some precautions have to be taken to get a good read everytime.

- Stand firm, do not move your head
- Do not cover your face
- Stay calm, do not make extreme facial expressions like sticking your tongue out or cringing your face
- Do not stand too close or too far from the Face ID 4.

Adding User Information

User information can be added into the Face ID 4 via two ways. One is through the terminal and another is through the TCMS V2. To add/change user information via the Face ID 4, press Menu > User > Select Employee ID > Edit/Add > Save. To search for users by name, click on the alphabets at the bottom of the screen.

Field	What can you do?
USER ID	Edit user ID based on your company's employee numbering system. Maximum length of user ID is 9 digit
NAME	Edit/Add name of in this field. Maximum number of characters is 24
FACE	To show quantity of face templates store.
CARD	Delete/Add Card
PASSWORD	Delete/Add Password
PRIVILEGE	Change privilege of users
USER ACCESS	Change Verify Type, Time Zone of the users

It is recommended that the updating of user information be done through the TCMS V2 software. After the information is updated, sync the TCMS V2 and the Face ID 4 to display the information.

Deleting User

Only an administrator can perform user deletion at the Face ID 4. To delete certain user(s), press Menu > User > Select User ID to delete > Press Delete > Press Yes to confirm > Press Delete another time for confirmation.

Access Level/Privilege

The Face ID 4 offers four types of access level or privilege.

PRIVILEGE	USER ROLES
Normal User	Only use the terminal to verify your identity. You cannot access into the Menu and make changes on settings and system.
Enroller	You are allowed to access into the menu to enroll user only.
Administrator	You are allowed to access into the menu to enroll users only and edit simple settings and system excluding access options and advanced options.
Supervisor	You are allowed to access into the menu to enroll users and edit settings and system.

5 • SYSTEM

General Settings

ADJUSTING DATE/TIME

The Face ID 4 is a terminal that records time attendance and door access* activities (**Face ID 4d only*) of employees. Precision in time and date cannot be compromised for the system to work efficiently. Adjust Date/Time according to your time zone. Press Menu > Date/Time > Select Value > Save

DATE FORMAT

Date format can differ based on countries for example in America, month-date-year format is used while in Asian countries the month comes first. Choose your date format according to your preference. The default format is dd-mm-yy. Press Menu > Date/Time > Select Format > Save

SOUND OF KEYBOARD

The Face ID 4 emits a sound when you press any of its buttons. To turn on/off the keypad sound: Press Menu > System > General > Keyboard beep > On/Off > Save

VOICE

The Face ID 4 has certain voice commands to guide users, during enrollment and to notify users during verification. Press Menu > System > General > Voice > On/Off > Save

VOLUME (LOW/MID/HIGH)

Voice Control lets you control the level of volume emitted by Face ID 4. The default volume of the Face ID 4 is Mid. To sustain the performance of speaker in Face ID 4, it's recommended to stay at Mid. To adjust the volume, press Menu > System > General > Volume > Low/Mid/High > Save

Display Settings

Customize the Face ID 4 display to your preference and requirements.

SYSTEM LANGUAGE

The Face ID 4 offers various languages to match your local requirements. A maximum of 3 language packs are available in the Face ID 4 and it is set according to your request during purchase. The default language is English. Press Menu > System > Display > Language > Choose your language > Save

VIEW TOOLBAR



You can choose to either hide or display the toolbar on the screen.

Always Display: The toolbar will always be displayed at the side of the screen.

Auto Hide: The toolbar is hidden and will reappear when you touch the soft touch panel. Menu > System > Display > Toolbar > Choose your style > Save

SLEEP TIME

Sleep time is a period before the Face ID 4 goes into sleep mode. This setting is available as a power saving feature of Face ID 4. The time range is from 0-99 minutes. Menu > System > Display > Sleep Time > Determine your time > Save

Face Settings

SETTING THRESHOLD

Threshold is a level of infrared scanner's sensitivity. Threshold determines how many percent of your face is being read by the system. The higher the threshold level, the more percentage is being read, the more restricted the system. Configure the threshold for 1:1 and 1:N methods.

For 1:1, the range is from 0-99 and the recommended value is 70.

For 1:N, the range is from 0-99 and the recommended value is 80.

Menu > System > Face > 1:1 Threshold/1:N Threshold > Input your value > Save

CAMERA EXPOSURE

You can adjust the light exposure level of infrared cameras in the Face ID 4. Improper value to the settings could affect the performance of the camera. The recommended value is 320. Menu > System > Face > Exposure > Input your value > Save

ADJUSTING IMAGE QUALITY

To determine the quality of face images captured by the Face ID 4 cameras during enrollment and verification, you can adjust the quality - the recommended value is 80. Press Menu > System > Face > Quality > Input your value > Save

Log Settings

Every time the Face ID 4 is being used, transaction logs are kept in the memory. These settings are for the Face ID 4 to regulate housekeeping of logs.

LOG ALERT

When log storage is at a certain level, users/administrator need to be alerted to avoid underperformance of the terminal. The recommended value is 99. Menu > System icon > Log Settings> Log Alert > Input your value > Save

- Dup Punch Period > 0 min
- Work code mode > None
- Card only > No
- Face detect interval > 2s

System Information

This option allows installers to check the information of the terminal including storage, firmware, algorithm, etc. To retrieve the Face ID 4's System Information. Press Menu > Sys Info > Record/Device

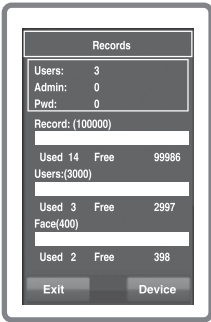

RECORD

Shows free storage and used storage of the Face ID 4 detailing user count, admin count and password user. It also displays other information such as face templates, log templates that been used and available.



DEVICE

A tap on device displays Device Name, Serial Number of the terminal, MAC Address, Face Algorithm, Firmware Version, Manufacturer and Manufactured time.

6 • DATA

Every time an enrollment is performed or verification is done, a transaction log is stored inside the Face ID 4. The data contains Terminal ID, date, time, user ID and transaction activities. For example, 0105021009000000000010000:

Description	Code
Terminal ID	01
Date (ddmmyy)	050210
Time (hhmm)	0900
User ID	000000001
Transaction Code	00
Terminal Activity	00

These logs need to be managed to maintain the effectiveness of the terminal. It is recommended to do the housekeeping of data from the TCMS V2 software but there are 5 functions available in Data icon to enable you to manage your data in Face ID 4.

Deleting Transaction Logs

Please make sure that you are certain when you want to do this operation. The logs that are stored inside the terminal are the ones that have not been downloaded into TCMS V2. Deleting the logs means that no backup data available.

If you are not using TCMS V2 software but a 3rd party software, make sure that you have already downloaded the transactions before you proceed to delete.

Menu > Data > Delete Transactions > Confirmation is required (Yes/No)

Deleting All Data

This function allows you to delete all attendance data and user information in the terminal. Make sure that all user information has been backed up in TCMS V2 before performing this task. Menu > Data > Delete All Data > Confirmation is required (Yes/No)

MANAGING USER PRIVILEGE

There are 4 administrator privileges in the Face ID 4, supervisor, administrator enroller, user. You can delete the administrator and supervisor privilege but without an administrator, normal users can access the menu easily and interrupt the settings. Menu > Data > Clear Administrator > Confirmation is required (Yes/No)

RESETTING TO FACTORY SETTINGS

There are some instances, which require you to restore the Face ID 4 to original factory settings. Upon completion of this task, the Face ID 4 will no longer keep your settings in all functions. Please redo all the settings to suit to your company's requirements.

Menu > Data > Restore to Factory Settings > Confirmation is required (Yes/No)

DELETE RECORDS

In the event where you will not be using the TCMS V2 software to download records or you do not need the transaction records, you may delete the records manually. This is to avoid the records from exceeding the storage limit of the Face ID 4. Besides that, you will also need to delete the records if you are using a USB flash disk to download transaction records from the Face ID 4 to avoid hang issue.

To delete the records: Press Menu > Data > Delete Transaction > OK to confirm.

7 • USB

Understanding the Need for USB Flash Disk

Communication between the Face ID 4 and a PC is very important to upload and download transaction data for time attendance and door access reports. The Face ID 4 offers communication options such as LAN and USB (Universal Serial Bus) connectivity. USB can connect Face ID with a computer for download and upload of user information and transaction logs.

Type of USB

There are various types of USB flashdisks available in the market. The Face ID 4 can only work with USB flash disks that supports minimum Linux Kernel 2.4.x, works fine with Imation, Transcend and Pen Drive (minimum support Linux Kernel 2.4.x) To determine the type of USB compatible by FingerTec terminal, please refer to this link at fingertec.com/newsletter/HL_74.html

Downloading Attendance Logs

To download attendance logs from the Face ID 4 to the computer: Menu > USB > Download Transactions. After the download process is complete, eject USB flash disk from the Face ID 4 and connect it to your PC that has been installed with the TCMS V2. Upload the data from the USB into the TCMS V2 for further processing.

Downloading User Data

Enrollment of user must be done at the Face ID 4 and during enrollment user data such as name and user ID are inputted. To sync the data in the Face ID 4 and computer: Menu > USB > Download User

Uploading User Data from USB to Terminal

While an administrator can input user data into the Face ID 4, the rest of the user information is completed in TCMS V2. Get the latest updates of user information from TCMS V2 to the Face ID 4 terminal using USB Flash Disk. Menu > USB > Upload User

Uploading User Photo

User photo can be included in user information in TCMS V2. To get the same photos being displayed when users gets verified, upload the user photo from the TCMS V2 to Face ID. The size of each photo must be 320 x 240 resolution. To do it using USB Flash Disk: Menu > USB > Upload User photo

8 • SHORTCUT KEY

Shortcut Keys in Short

Shortcut keys give you quick access to your most used functions. A total of 6 shortcut keys are available for you to configure. They are labeled with defined names and displayed on side of the screen.

Configuring Shortcut Keys

Menu > System > Shortcut Definition > Tap on the key one at a time and select the function you want for the specific key > Save

Some of the functions you can configure for your shortcut keys include status key, work code, viewing of sms.

9 • AUTO TEST

Who should do the Auto Test?

Auto Test page is to diagnose or analyze the conditions in the Face ID 4. There are several tests available in the Auto Test page and only an administrator is allowed to perform the tests. Before running any tests, kindly contact your reseller for advice or you could email support@fingertec.com.

Is the Screen OK?

Test Screen determines the quality and sensitivity of the Face ID 4 touch screen panel. You will see lines of different colors; click the screen to continue testing. If there's a broken line or distorted colors on the screen, kindly send your Face ID 4 for repair. Menu > Auto Test > TFT Test

Checking the Voice Message

Test Voice determines the quality of the Face ID 4's audio. Every click on the screen will emit different voice message. If you find any distorted sound in any of the voice message or instruction, kindly send your Face ID 4 for checking. Menu > Auto Test > Test Voice

Checking the Infrared Camera

To know the condition of the infrared face scanner, you need to run face test. The Face ID 4 will display 2 images of your face: color display and infrared. Make sure both cameras capture and show your face image. Look at the infrared camera capture image, make sure it is a square in the middle of the screen; you have to look into the camera. If you can see your image in the square, the camera is working fine. Check the quality status bar to adjust to the best capture image. Otherwise, kindly send your Face ID 4 for checking. Menu > Auto Test > Test Face

Is the Time Accurate?

Time is an essence in the Face ID 4 and it can't be compromised. The Test Time will display date, time, 0 (s): 0 (ms). Tap the screen to start the test. The 0 (s): 0 (ms) will start to run and every 10ms change the second to 1. If it doesn't run well, kindly send your Face ID 3 for checking. Menu > Auto Test > RTC Test

10 • CALIBRATION

Calibrating Screen Sensitivity to Default Level

[Menu](#) > [Auto Test](#) > [Calibration](#)

The screen will display five dots, one at a time in all corners of the screen and one at the center. You need to touch the center of the dot for the system to calibrate the screen automatically. When the process is done, the screen will return to the main menu.

Definition of Schedule Bell

Schedule bell is a function to alert employees or users at a certain time based on your company's scheduling and preference. For example, a group of employee's lunch time is at 10:30a.m while the other group is at 2:00p.m. The Face ID 4 offers up to 15 schedules you can define.

Menu > Date/Time > Bell > Choose the options that you want to change and change the value accordingly > Save

Inserting Day and Time to Trigger Schedule Bell

The screen displays 00:00 as default time. A tap on the selected bell will bring you to another setting page. Input the day/time you want the bell to ring, day. The time format is 24:00 hours.

Determining the Ring Type of Schedule Bell

The Face ID 4 offers various type of ringtones to choose from. A tap on the ringtone will change the sound of the bell. Select the one you prefer.

Repetition

How many times do you want the bell to ring? A tap on the value will prompt the keypad. Input the numbers and the bell will ring according to your settings.

State

You can enable or disable the schedule bell with a tap on Enable/Disable bar.

TROUBLESHOOTING

“UNABLE TO CONNECT” APPEARS

When this message appears, it means that the settings for the Face ID 4 and the computer are not properly done. Find out which method you are using to connect. The Face ID 4 offers LAN and USB communication methods. Refer to Chapter 3 to further understand the topic.

“ADMIN AFFIRM” APPEARS

You are not the administrator of this Face ID 4 terminal. Only an authorized administrator of the system is allowed to access the Menu. Any attempt from a normal user to access the Menu will prompt “Admin Affirm” message on the screen. In case the administrator has resigned from the company, kindly contact your FingerTec authorized reseller to access the terminal.

THE TERMINAL DOESN'T READ YOUR FACE

Have you stood properly with out making any facial expressions? Your position from the camera must be in a proper distance from the camera. If you see your reflection at the camera, you are at the right position. Now, were you making facial expression during verification? Stay calm and look at the camera, and please do not cover your face with anything. Have you tested the camera of the Face ID 4? The camera might not be working properly. Test your camera's performance. Refer to Chapter 9 to Test the Face Camera.

THE LED IS BLINKING ALL THE TIME

You have nothing to worry about unless the blinking light is red. The green blinking light is indicating that the terminal is in the standby mode. Red blinking light may signal a problem in the Face ID 4. Contact your reseller for consultation.

RFID CARD DOESN'T RESPOND

Have you registered the card to the terminal? The card must be registered to the Face ID 4 before the terminal could read the information in the card. Refer to chapter 4 User for card enrollment.

NO SOUND

Two possible causes for this problem: The Face ID 4 voice mode is silent. Perhaps someone has turned off the voice in your Face ID 4 or reduced its volume to 0%.

Speaker is damaged. Once you have rectified the voice mode and the problem persists, proceed to test the voice (Chapter 9). If no voice is emitted, contact your local reseller for support.

OTHER RESOURCES

Information About FingerTec

TO LEARN ABOUT	GO TO?
Company and the products	www.fingertec.com
The latest updates	Facebook Fan Page: FingerTec Worldwide Twitter: FingerTec To subscribe for FingerTec newsletter: info.fingertec.com/subscribenewsletter
Technical Tips and Latest Product Updates and Upgrades	user.fingertec.com
Email	info@fingertec.com (Sales) support@fingertec.com (Technical)
Register for Warranty	info.fingertec.com/productwarranty
FingerTec Accessory	accessory.fingertec.com

Copyright Notice & Disclaimer

COPYRIGHT NOTICE

All rights reserved. No part of this book may be reproduced or transmitted in any form or by any means, electronic or mechanical, including photocopying, recording, or by any information storage and retrieval system, without written permission from FingerTec Worldwide Sdn Bhd. Every precaution has been made to supply complete and accurate information. Information in this document is subject to change without prior notice.

DISCLAIMER

No person should rely on the contents of this publication without first obtaining advice from a qualified professional person. The company expressly disclaims all and any liability and responsibility to any terminal or user of this book, in respect of anything, and of the consequences of anything, done by any such person in reliance, whether wholly or partially, upon the whole or any part of the contents of this book.

FINGERTEC WORLDWIDE SDN BHD

